

1.2.E - 02/2020

Dok. Nr. 2.020.022.1.a

www.janitza.com

Power Factor Controller

Prophi® 15T-III

Manual



Janitza electronics GmbH
Vor dem Polstück 6
35633 Lahnau / Germany
Telefonischer Support: +49 6441 9642-22
E-Mail: info@janitza.com
www.janitza.com

Janitza®



CAUTIONS:

1. High voltage !
2. The device may only be used indoor !

CONTENTS

Section 1	General	p.3
Section 2	Installation and instructions for usage	p.4
Section 3	Connection alternatives measuring voltage and measuring current	p.6
Section 4	Display functions	p.8
Section 5	Display of grid parameters	p.9
Section 6	PROGRAM-MODE / Manual programming	p.11
	6.1 Programming lock	p.19
Section 7	HELP-function / actual assignment of outputs	p.19
Section 8	MANUAL OPERATION	p.21
Section 9	SERVICE MENU / Error storage	p.22
Section 10	EXPERT MODE	
	10.1 Expert-Mode 1	p.23
	10.2 Expert-Mode 2	p.25
Section 11	Control principle	p.26
Section 12	Interfaces	p.27
	12.1 Application: Controller-coupling	p.28
	12.2 Application: Hybrid-mode	p.29
Section 13	Alarm relay / Error messages	p.31
Section 14	Display-editor	p.31
Section 15	OSCI-MODE	p.31
Section 16	Maintenance and warranty	p.31
 Appendixes/ Tables:		
	Annex 1	p.32
	Control series table	
	Control series editor	
	Annex 2	p.33
	Troubleshooting	
	Annex 3	p.35
	Technical data	
	Annex 4	p.37
	Factory settings	
	Annex 5	p.39
	Operation diagram	

Section 1: GENERAL

The power factor controller Prophi-15T-III is the consequent follow-up development of the well proven series Prophi.

The main distinctive feature is the new 3-phases measuring system. Due to the 3-phases recording of voltage and current the device allows a convenient usage as grid measuring device and as power factor controller.

All measuring values can be edited and may be displayed in big letters for easier readability.

2 interfaces are standard. By means of the comfortable windows-software that is included in the delivery and by using one interface for a connection to a PC the execution and evaluation of grid measurements is possible. The second interface can be used for customer specific purposes.

Used as PF-controller various control modes are available. They allow not only to control according to the phase with the highest load or the average demand of the phases, but also to realize a real single-phase control (balancing) or a mix of balancing and conventional three-phases-control.

For an easy usage the concept of graphic menu navigation has mainly been adapted.

New are amongst others an integrated help (HELP-button) and the possibility to jump back in the programming menu by an additional ESCape-button.

The usage of a fully graphic support display allows an additional Oscilloscope-Mode where the phases (half waves) of voltage and current can graphically be displayed.

- 3 x 5 free programmable switching outputs
- 1 alarm relay, 1 programmable message relay, 1 relay for the cabinet fan
- Operating voltage: 110 ... 230VAC (+/-15%)
- Measuring voltage: 3 x 30 ... 440 VAC (L-N) / 50...760 V (L-L)
- Measuring current: 3 x 5A / 1A
- Pre-programmed control series and control series editor
- Illuminated graphic display 128 x 64 dot, graphical menu navigation
- 4-quadrant-operation
- Measuring of capacitor current possible
- Three-phase display of various grid parameters (U, I, F, Q, P, S Delta Q ...)
- Switch over to large display possible
- Display up to 31st harmonic of voltage and current
- Simultaneous graphical display 1 period of voltage and current in Osci-mode
- Monitoring of temperature
- Storage of maximum grid parameters with time stamp
- Manual/automatic operation
- Programming of fixed steps or masking of particular outputs possible
- Control possible as 3-phase, 1-phase or mixed-mode
- Display of different error messages
- Error storage
- Complete 2nd parameter set programmable
- 2 integrated separate interfaces
- Integrated clock, several timers possible
- Integrated help-function/plain text
- Panel-mounted instrument 144 x 144 x 60 mm

Section 2: INSTALLATION AND INSTRUCTIONS FOR USAGE

The controller is designed as panel mounting instrument in PFC-systems. This requires a cut out of 138 x 138 mm according to DIN 43700 / IEC 61554. The controller has to be inserted from the front and fixed with the clamps (included in delivery). The device may only be installed by qualified personnel and may only be operated according the given safety regulations. In addition the relevant legal and safety instructions have to be obeyed.

The measuring input is designed for 1- and 3-phase grids.
The maximum measuring voltage is 440V~ (L-N) / 760V ~ (L-L).
The supply voltage is 110...230 V +/-15%.



Wiring connections must be suitable for the particular voltages. Input leads have to be protected by over-current-protection devices. The supply voltage must be protected by a fuse; it must be possible to switch off the supply voltage by a separator.
The device must not be operated without protective earth contactor connected!

Before connecting, it has to be checked that all connections are at zero potential; current transformers have to be short circuited. Correct phasing of measuring voltage and measuring current have to be checked. The measuring current circuits must be wired with minimum 2.5 mm² Cu.

Terminals may only be plugged when de-energized!



Attention!

The controller may only be operated when installed. The complete programming of all application-specific parameters is done according chapter programming. Then the device is set to automatic operation by pushing the operation mode button. The controller is now ready for operation.



Operating the controller without following to these operating instructions may be harmful and dangerous!

The controller is supplied for a standard operating voltage of 110...230VAC (+/-15%), a measuring voltage of 30...440 V~ (L-N) resp. 50...760V~ (L-L), 50/60Hz, and a measuring current of 5A or 1A (programmable). A voltage converter is required for different operating voltages.



Caution!

Voltages which exceed the allowed voltage range can damage the device!



Front view

- | | | |
|---|-----------------------------|-----------------------|
| Operating mode:
- Automatic
- Program.
- Manual oper.
- Service
- Expert Mode
- Osci - Mode
- Display Editor | Increase selected parameter | HELP opens Help pages |
|---|-----------------------------|-----------------------|



ENTER/ OK Confirmation storage of values

Reduce selected parameter

Escape previous page/value in the display

Rear view

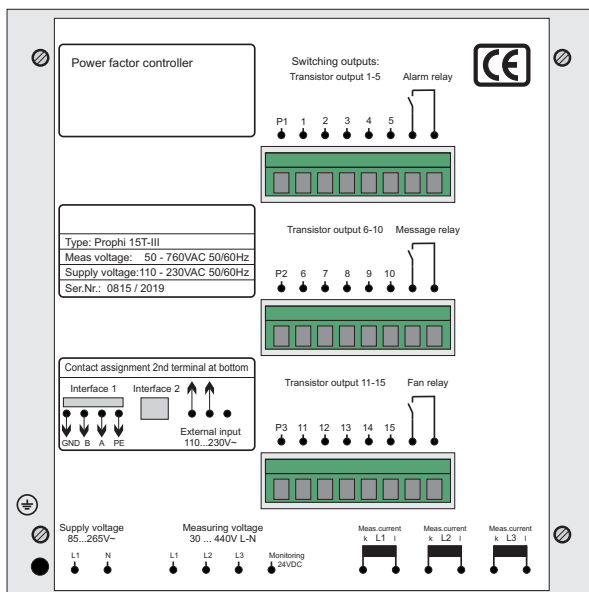

The allocation of switching outputs 1 ... 15 to the capacitors complies to the selected connection variant and the desired CONTROL-MODE (Programming/point 2)

Especially in "Mixed Mode" where some outputs are used for single phase capacitors, others for 3-phase-capacitors the proper connection must be assured!

In the "HELP"-menu the controller directly displays the actual correct allocation of outputs (AUTO-MODE: Help-page).

For examples also see page 12.

Section 3: CONNECTION ALTERNATIVES MEASURING VOLTAGE AND MEASURING CURRENT

According to the existing grid and the desired operating mode (CONTROL-MODE Programming) the controller has to be connected accord. one of the following alternatives. The separate auxiliary voltage (24 V DC) that is needed for the thyristor switches has to be conducted to P1...P3 and to the connection "control 24V". **The connection of PE is mandatory!**

Alternative 1: measuring performed in each phase - 3 current transformers needed
 Use: CONTROL-MODE: 1 - 4; 7-12; 15 (control modes see page 11)

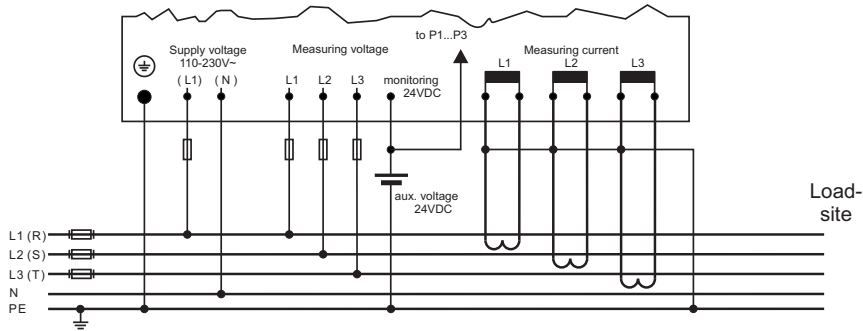

Alternative 2: single-phase measuring via current transformer in L1 Values extrapolated (balance assumed).
 Measuring complies with conventional measuring for switching of three-phase capacitors.
 Use: CONTROL-MODE 5; 13; 14; 16

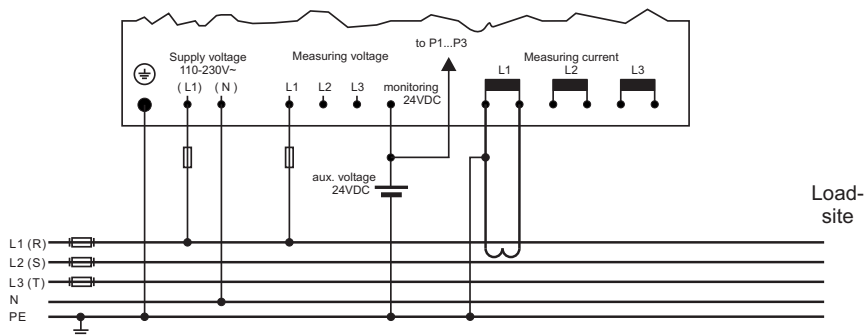

Alternative 3: single-phase measuring as alternative 2, but with capacitor current measuring in the compensation system for collection of real capacitor currents.
 Use: CONTROL-MODE 6

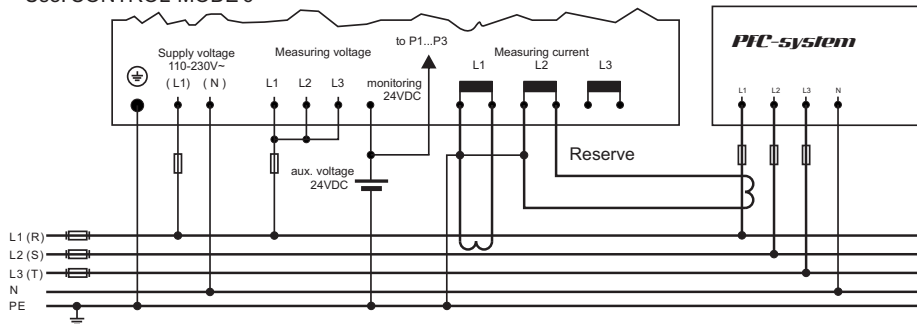

Connection of current transformer / sum current transformer

When installing the current converter, care should be taken to ensure that the load current flows through it. The outputs of the compensation network must be installed behind the current converter (in the direction of current flow). If the controller is connected up via sum-current converters, the overall conversion ratio is entered.

Example:

- C.converter 1: 1000/5A
- C.converter 2: 1000/5A
- Sum-current converter: 5A+5A / 5A

- C.converter ratio is: 2000 /5A

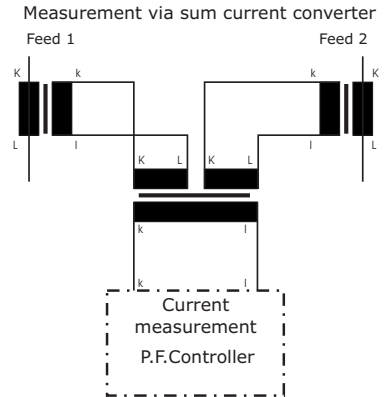

Caution!

The secondary clamps of the CT have to be short circuited before current leads are interrupted !

High Voltage Application

The example shows the connection in HV-application. The measuring current is taken off primary via X/1A transformer. Measuring voltage produced via transformer 20000/100 V. In this case, the Prophi 15T-III has to be programmed as follows:

- 4 I-CONVERTER sek: X / 1A
- 14 MEASUR.VOLTAGE: 100 V
- 15 V-CONVERTER: 20kV / 100 V

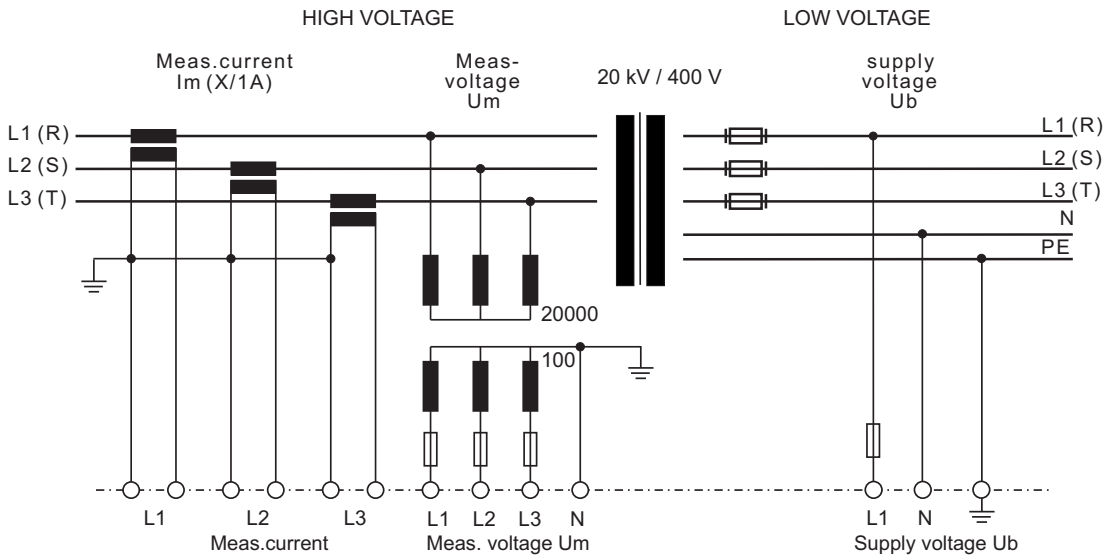

Section 4: DISPLAY - FUNCTIONS

After the operating voltage has been switched on, the controller briefly indicates with description and software-version before changing to automatic operation.

Actual values and symbols of the particular operation state are shown in the display. In the automatic operation (standard) capacitor steps are automatically switched on or off to reach the pre-set target cos-phi. This happens when the required reactive power is higher than the value of the smallest capacitor step.

Example 1: Automatic operation

L1...L3: Individual compensation by single-phase capacitors

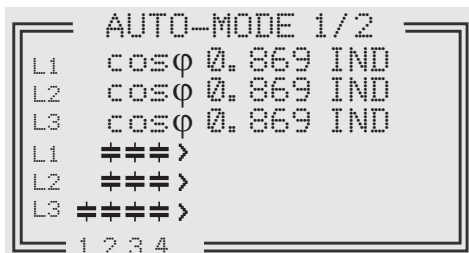

Example 2: Automatic operation (Mixed Mode)

L1...L3: phase wise compensation by single phase capacitors

Σ: Three-phase capacitors activated

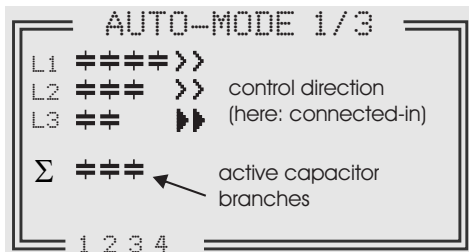

Example 3: Automatic operation

Measuring in one phase

Controlling of 15 three-phase-capacitors

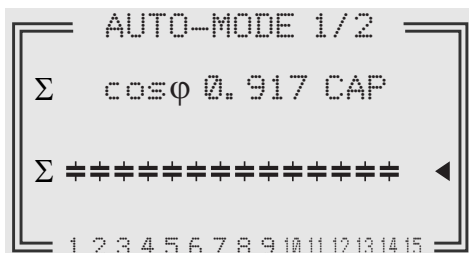

Number of switching outputs until end stop.
Here: 15 three-phase capacitors, end-stop: 15

Control direction is symbolized by a compact arrow:

- ▶ Connecting-in
- ◀ Connecting-out

The connecting-in arrow is always located after the maximum possible number of stages (end stop)

- > An open arrow indicates that the required blocking time (Discharge time) is running before an impending switching step
- >> A double arrow symbolizes switching of several branches

Σ The sigma-sign indicates the three-phase-value (mean-value) resp. activated three-phase-capacitors

A Alarm relay activated (declines in case of error)

S Message relay activated: "SUPPLY"

U Message relay activated: "Undercurrent"

H Message relay activated: "Harmonics"

F FAN-relay: ON

≡ The particular capacitor outputs are permanently monitored. Inverse display = capacitor out of range

2 Display of 2nd parameter-set

↑ Supply display (i.e.generator operation)

T 2nd Target-cos phi activated by timer

↑ 2nd Target-cos phi activated by supply

Section 5: DISPLAY OF GRID PARAMETERS

Display of 3 selected grid parameters

In Auto-Mode, button \uparrow leads to display mode 1. Here 3 (free selectable) grid parameters are displayed in large letters. The selection and storage of these values is done in the Display- Editor.

Example: Display mode 1:

Desired values selected in the Display Editor (see section 14)

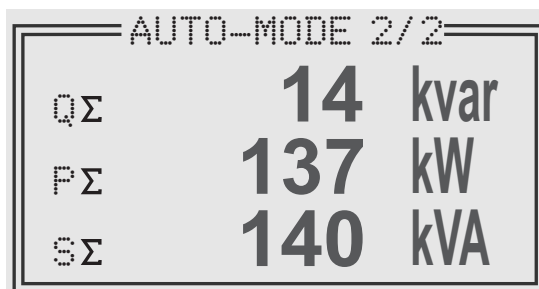

Display of particular grid parameters (from AUTO-MODE by pressing ENTER)

By repeated activation of the "ENTER"-button (in automatic operation) several grid parameters can be displayed (s. table below):

Action	Display	Unit	in%	large display possible	Bargraph possible	3-phase
ENTER	1 LINE VOLTAGE	V		x		x
ENTER	2 APPARENT CURRENT	A	x	x		x
ENTER	3 REACTIVE POWER	kvar		x		x
ENTER	4 ACTIVE POWER	kW		x		x
ENTER	5 APPARENT POWER	kVA		x		x
ENTER	6 DIFF. kvar to target	kvar		x		x
ENTER	7 TEMPERATURE	°C / °F		x		
ENTER	8 3.-31. HARMONICS	V/ I	x		x	x
ENTER	9 HARMONICS THD-V/I		x		x	x
ENTER	10 Comp.- power	(only at real capacitor current measurement)				
ENTER	11 TIME / DATE	\uparrow / \downarrow change the date format				
ENTER	12 Software version					
ENTER	return to: 1					

Buttons \uparrow / \downarrow change the display format:

The values can be displayed in their unit, in % or as large display resp. bar chart. Examples, see next page.

=== DISPLAY ===

Examples of different displays:

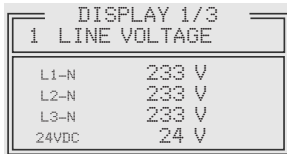

VOLTAGE 3-phas.

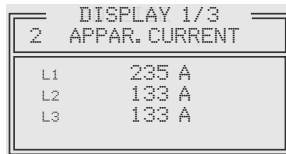

CURRENT: 3-phas.

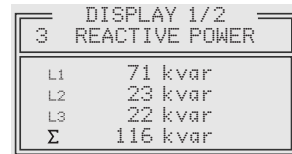

REACTIVE PWR 3-phas.

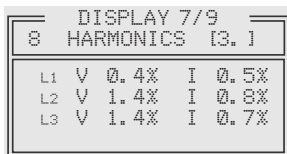

HARMONICS in %

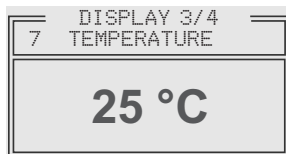

TEMPERATURE °C
LARGE LETTERS

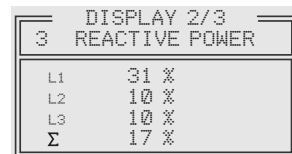

REACTIVE PWR in %

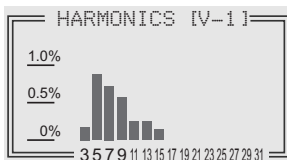

HARMONICS diagram

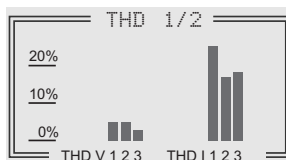

THD V/I as bar diagram

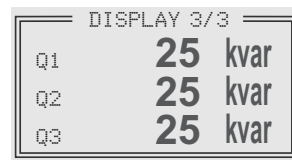

REACTIVE POWER
LARGE LETTERS

Repeated pressing of the "Operating Mode" key activates the various menus in sequence: **Automatic** operation - **Programming** - **Manual** (manual operation)- **Service** - **Expert** mode - **OsciMode** - **DisplayEditor** and back to Auto.

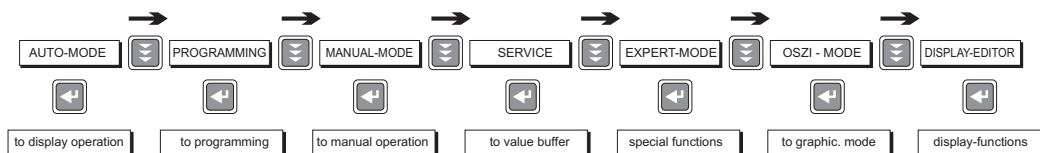

Section 6: PROGRAM-MODE (manual programming)

Pressing the button "Operation Mode" one time switches from automatic operation to the program mode.

The upper part of the display always shows the parameter, the adjustable values are shown in the lower part. Editable values are generally given in square brackets. Changes of these values can be done by the buttons \uparrow / \downarrow . By pressing the "ENTER-button" the value is stored. Pressing the "ESC"-button allows to go one step back (without storing).

1 LANGUAGE

This selects the language of the operating menu
[GERMAN, ENGLISH, SPANISH, RUSSIAN, TURKISH]

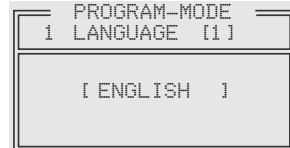

2 CONTROL-MODE [1...16]

16 different controlling operation modes can be adjusted at the Prophi 15T-III according the following table:

Mode No.	Kind of measurement(number CT) see page 6	Number/type of capacitors	Connection of capacitors	Operation mode
1	3-phase	3x 5 single phase	L-N	Stand-alone
2	3-phase	max.3x4 1-phase + Rest 3-phase	L-N 3-phase	Stand-alone MIX - MODE
3	3-phase	3x 5 single phase	L-L	Stand-alone
4	3-phase	1x 15 threephase	3-phase	Stand-alone
5	1-phase	1x 15 threephase	3-phase	Stand-alone
6	1-phase	1x 15 threephase	3-phase	Sytem current meas. internal via L2 / L3
7	3-phase	3x 5 single phase	L-N	Hybrid mode 1x Prophi 12RS
8	3-phase	3x 5 single phase	L-N	Hybrid mode 2x Prophi 12RS
9	3-phase	3x 5 single phase	L-L	Hybrid mode 1x Prophi 12RS
10	3-phase	3x 5 single phase	L-L	Hybrid mode 2x Prophi 12RS
11	3-phase	1x 15 three phase	3-phase	Hybrid mode 1x Prophi 12RS
12	3-phase	1x 15 three phase	3-phase	Hybrid mode 2x Prophi 12RS
13	1-phase	1x 15 three phase	3-phase	Hybrid mode 1x Prophi 12RS
14	1-phase	1x 15 three phase	3-phase	Hybrid mode 2x Prophi 12RS
15	3-phase	1x 15 three phase	3-phase	Coupling mode
16	1-phase	1x 15 three phase	3-phase	Coupling mode

=== PROGRAM-MODE ===

CONTROL-MODE [1]:

3-phase measuring / max. 3x5 single phase capacitors L-N

(3 current transformers needed), values displayed and calculated per phase. Connection of measuring current and measuring voltage (refer to page 6). Controlling is done with max. 5 outputs per phase in case of switching of single-phase capacitors L-N.

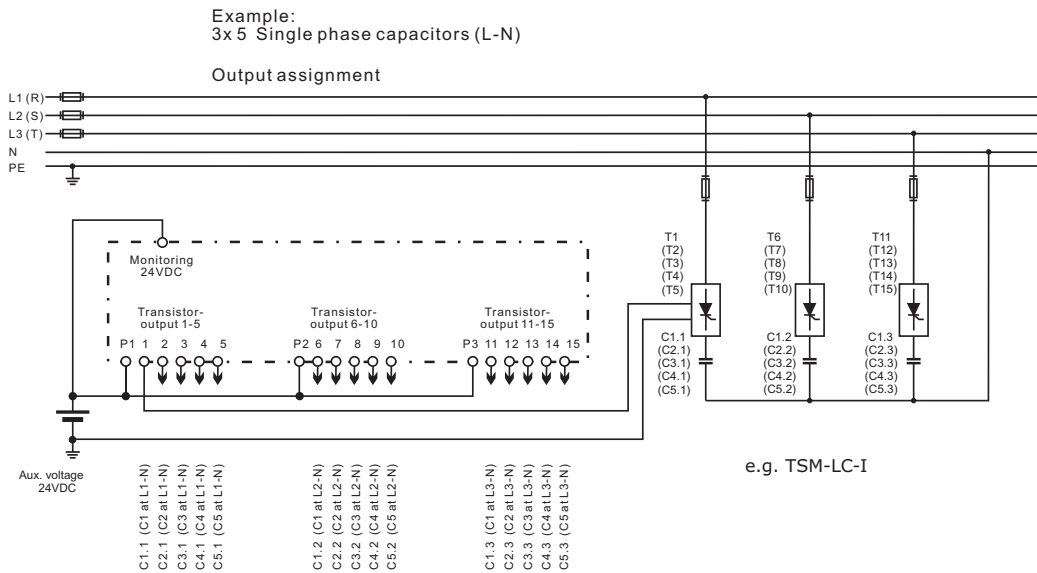

Allocation of switching outputs 1...15 to the capacitors according to the selected connection variant and the desired CONTROL-MODE.

Especially in "Mixed Mode" where some outputs are used for single phase capacitors, and others for 3-phase-capacitors the proper connection must be assured!

In the HELP-function the controller directly displays the correct allocation of outputs (AUTO-MODE: Help-page 7-9).

=== PROGRAM-MODE ===

CONTROL-MODE [2]: MIXED-MODE 3-phase measuring

3 current transformers required. Values displayed and calculated per phase. Connection of measuring current and measuring voltage see page 6/Var.1.
 Controlling done with max. 4 outputs per phase for switching of single phase capacitors L-N. The rest of the outputs (min. 3, max. 12) are used for switching of three-phase capacitors to control the base load.
 Partitioning into single-phase / three-phase capacitors is done at Programming: 5 ENDSTOP!
 The allocation of the switching outputs to the particular capacitors can be retrieved in AUTO-MODE on HELP-pages 7...9.

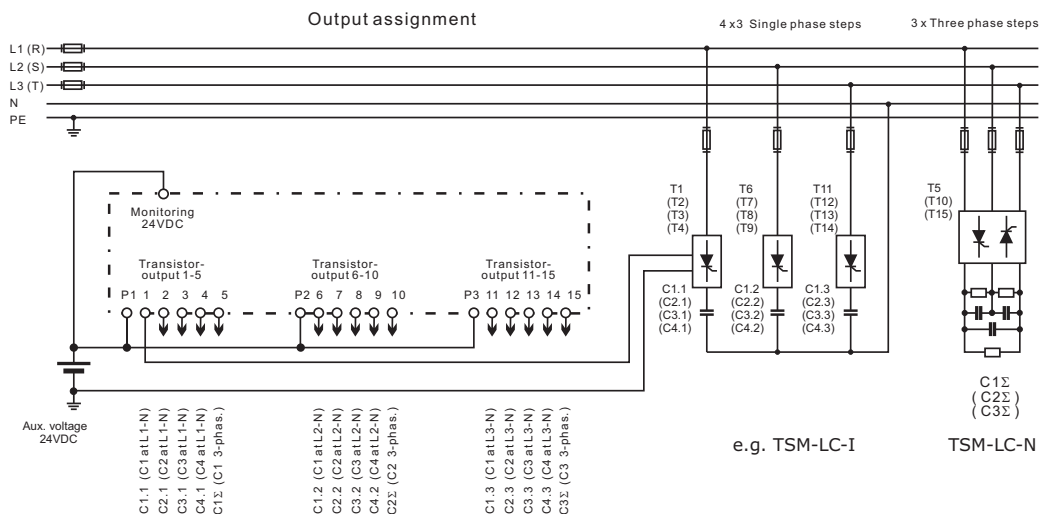

CONTROL-MODE [3]: 3-phase measuring / max. 3x5 single-phase capacitors L-L

3 current transformers required. Values displayed and calculated per phase.
 Controlling done with max. 5 outputs per phase, switching of single phase capacitors L-L

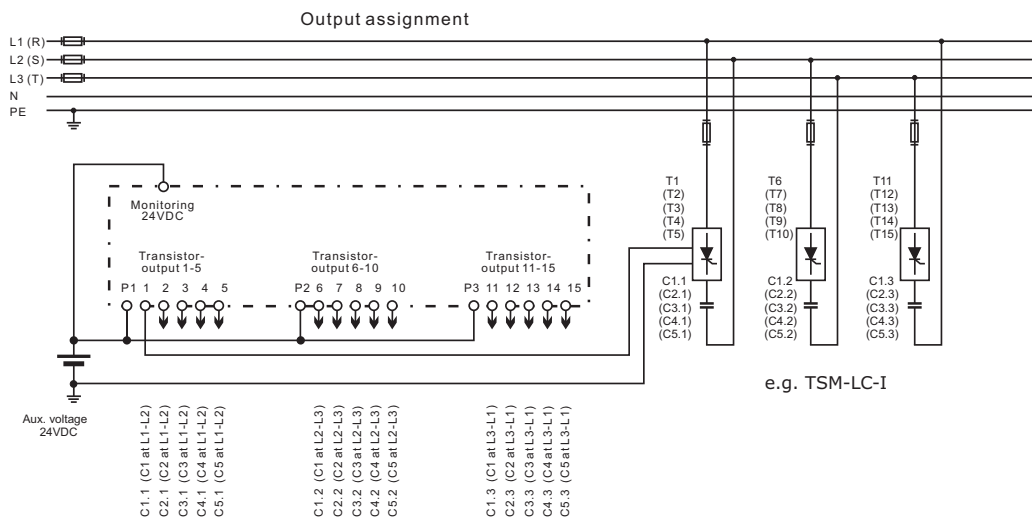

=== PROGRAMM-MODE ===

CONTROL-MODE [4]: 3-phase measuring / max. 15 three-phase capacitors
CONTROL-MODE [5]: 1-phase measuring / max. 15 three-phase capacitors

Connection of current and voltage compare page 6/ Var.1 resp. Var.2
 Controlling of 15 outputs

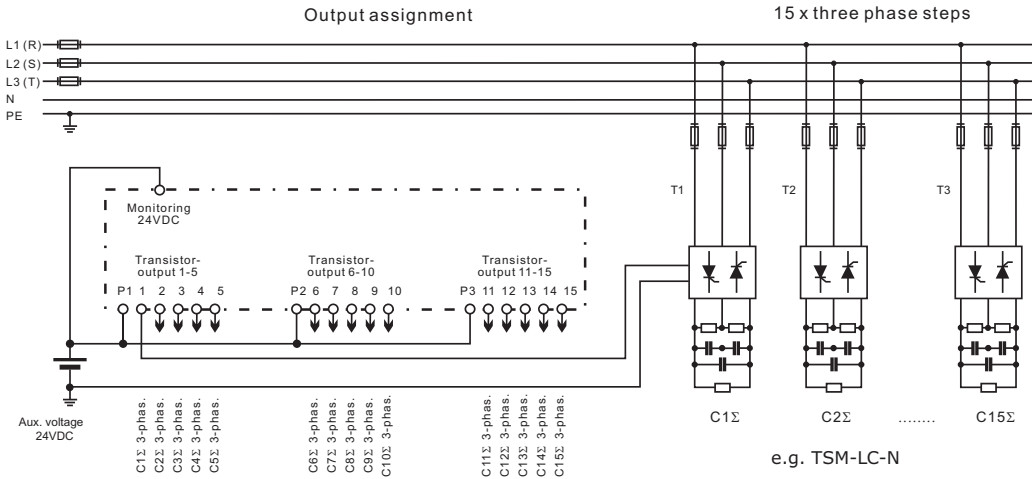

CONTROL-MODE [6]: 1-phase measuring / max. 15 three-phase capacitors with capacitor current measurement

According variant 5, but the free current inputs (L2 or L3) are used for capacitor current measurement for real monitoring of capacitors.

CONTROL-MODE 7 - 14: HYBRID-MODE

The connection of the outputs is done according the related switching diagrams MODE 1-4. In Hybrid-Mode the *Prophi 15T-III* is connected with one or two controllers *Prophi 12RS* via the system interface (Interface2). In this case the *Prophi 15T-III* takes over the dynamic part and the *Prophi 12RS* takes over the slowly changing loads (s. application page 29).

CONTROL-MODE 15 - 16: COUPLING MODE

The coupling mode is used to couple 2 independent dynamic compensations systems which are connected to each other via a coupling switch. The signal of the coupling switch is fed to the master controller (s. application page 28).

=== PROGRAM-MODE ===

3 I-CONVERTER PRIM [1000] A / X (5 ... 13000) A
 Selects the primary current of the current converter.
 Sequential adjustment of L1...L3.
 via the \uparrow / \downarrow keys. Save and continue with ENTER

PROGRAM-MODE	
3	I-CONVERTER PRIM
L1	[1000]A / 5 A
L2	1000]A / 5 A
L3	1000]A / 5 A

4 I-CONVERTER SEC 1000 A / [5] A (1 / 5 A)
 This sets the secondary current of the current converter.
 Selection via \uparrow / \downarrow . Save and continue with ENTER

5 END STOPP
 Programming of the maximum number of active capacitor branches.
 Depending on the selected operation mode the maximum number of connected capacitors at the output groups L1...L3 and (if available) for the output groups Σ (three-phase capacitors) are set.
 The visible symbols of the capacitors correspond to the connected outputs.
 Input via \uparrow / \downarrow . Save and continue with ENTER

PROGRAM-MODE	
5	END STOP L1-N
L1-N	***** [5]
L2-N	***** 5
L3-N	***** 5
	1 2 3 4 5

6 CONTROL SERIES [1] (1...20 + ED)
 The ratio of the capacitor branch powers determines the control series, the power of the first capacitor always being assigned the value 1.
 Selection of desired control series consecutively for L1...L3 and for Σ (three-phase outputs).
 If the required control series should not be present, the user may define a special one in control series "ED" (see Annex 1: Control-series editor)

PROGRAM-MODE	
6	CONT. SERIES L1-N
L1-N	12333 [3]
L2-N	12333 3
L3-N	12333 3
	1 2 3 4 5

7 CONTROL PRINCIPLE
 The control preference may be selected here:
SEQUENTIAL connection
LOOP connection
INTELLIGENT loop connection (default setting)
COMBINED CHOKE
 See Section 13 for an explanation of the control modes.
 Selection with \uparrow / \downarrow keys.
 Save and continue with ENTER

PROGRAM-MODE	
7	CONTR. PRINC. 3]
[INTELLIGENT]	

8 POWER 1st STAGE [0.01 ... 255.99] / [10...2550] kvar
 To determine the controller's response sensitivity, the dimensions of the smallest capacitor (stage 1) must be known. They are entered in two steps in kvar. The integral kvar values (before the comma) are initially selected via the \uparrow / \downarrow keys and saved with ENTER.
 The positions after the comma are then selected, again via the \uparrow / \downarrow keys.
 If the capacitor value is below the response sensitivity, a warning will occur (indication of "!" in the display)

PROGRAM-MODE	
8	POWER 1. STAGE
L1-N	[25] . 00 kvar
L2-N	25 . 00 kvar
L3-N	25 . 00 kvar

=== PROGRAM-MODE ===

- 9 TARGET COS PHI** [0.98 ind] (0.3 ind ... 0.3 cap)
 By setting the target cos phi, the power factor to be attained via the PF correction is defined.
 Save and continue with ENTER.

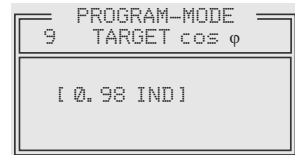

- 10 TARGET 2nd cosPhi** [NO] (1...3)
 1: NO (no 2nd target cosPhi, continue with 14)
 2: Timer (2nd cos-phi - activated by timer, scheduler with 12,13)
 3: Energy supply (2nd target cos-phi - activated by energy-supply)

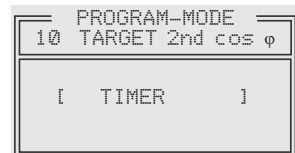

- 11 TARGET 2nd cosPhi** [0.9 IND] (0.3 ind ... 0.3 cap)
 Set point for the 2nd target cosPhi
 (only available if selected under 10)

- 12 SWITCH ON TIME** φ2 [HH:MM:SS]
 Switch-on time of the timer for the 2nd target-cos phi
 (only available if selected under 10)

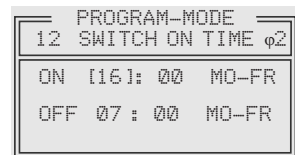

- 13 SWITCH OFF TIME** φ2 [HH:MM:SS]
 Switch-off time of the timer for the 2nd target-cos phi
 (only available if selected under 10)

- 14 MEASURING VOLTAGE** L-L [400]V (50...760) V
 Programming of measuring voltage.

The values programmed here always refer to the voltage at the clamps of the controller !

Selection via ↑ / ↓. Save / continue with ENTER

- 15 V-CONVERTER** [NO] (410V - 79kV / 400V)
 When a measuring-voltage converter (e.g. for HV-measurement) is used, its conversion ratio is to be programmed here.
 Selection via ↑ / ↓. Save / continue with ENTER

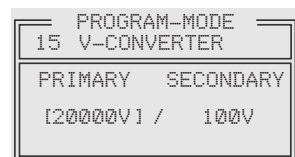

- 16 FREQUENCY** [50] Hz (50 / 60Hz)
 Input of the grid frequency of the measuring voltage
 (needed for measuring system)

- 17 CONNECTING TIME:** [1000] ms (50...1000ms)
 The time between connecting the capacitors to increase the momentary network capacitance. It should be noted that in practical operation the real connection time is affected by the discharge time (locking time).
 Selection via ↑ / ↓. Save / continue with ENTER

=== PROGRAM-MODE ===

18 DISCONNECT TIME: [1000] ms (50...1000)ms
 The time between disconnecting the capacitors to reduce the momentary network capacitance.
 Selection via ↑/↓. Save / continue with ENTER

19 DISCHARGE TIME: [1000] ms (50...1000)ms
 This is the time for which an individual output is blocked between disconnecting and connecting. It depends on the discharge device of the capacitor.
 Selection with buttons ↑ / ↓. Save /Continue with ENTER

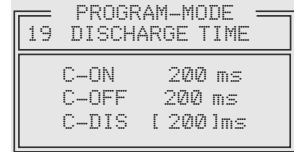

20 ALARM TEMPERATURE [55] °C (20...80)°C

The alarm temperature programmed here is the temperature at which a stepwise disconnection of the capacitors is performed. After 10 min. the standard **alarm relay** of the controller will respond. At the same time, the display shows the cause of the alarm (over temperature).
 When the temperature drops again, the required branches are automatically re-connected in steps.
 Selection with ↑/↓. Save / Continue with ENTER

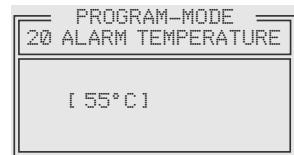

21 FAN TEMPERATURE [30] °C (ON/OFF/15...70°C)
 Threshold for the **fan relay** for control of a cabinet fan.

22 MESSAGE RELAY [Supply] (1...3)

The **message relay** can be programmed for one of the following options as required:

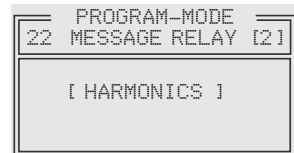

1 - OFF

2 - Supply: Message when active power is supplied.

3- Under current:

Message when the measuring current is not met. Signal is generated when the current value drops below the response sensitivity of the controller.

4 - Harmonics:

Message when the limiting value of the total harmonic distortion factor (THD-V) is exceeded. This value can be parameterized under "38 Harmonics" (in %).

5 - ERROR - System current measuring

6 - ERROR - Com1 (interface error)

7 - ERROR - Com2 (interface error)

8 - ERROR - Com1/2 (interface error)

Display: **S**

Display: **U**

Display: **H**

Display: **E**

Display: **E**

=== PROGRAM-MODE ===

23 EXTERNAL INPUT [NO] (1...4)

Setting of the desired action upon applying a control voltage of 110...230V~ at the external input.

1 - NO (no action)

2 - 2nd parameter set (switchover to 2nd parameter set)

This selection simultaneously activates the following points 24...37 for programming of the values of the 2nd parameter set.

3 - External error (Display of an error message)

4 - Coupling operation parallel

(Selection of coupling operation via 2 CONTROL-MODE)

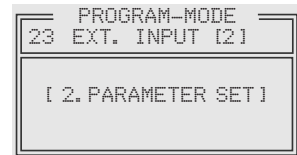

Programming of 2nd parameter set

(only active if 23 EXTERNAL INPUT is set to 2nd parameter set)

2

As a standard, the values of the 2nd parameter set equal the values of the normal parameter set. Possible applications are for example: changing of target cos-phi, switch-over of current transformer or switch-over the switching times.

By triggering a 110...230V~ signal at the external input, the 2nd parameter set is activated with following values:

2 24. I-converter prim

2 25. I-converter sec

2 26. End stop

2 27. Control serie

2 28. Control principle

2 29. Power 1st stage

2 30. Target cos-Phi (2nd parameter set) nominal value

2 31. 2nd target cos-Phi (2nd parameter set)NO/supply/Timer

2 32. 2nd target cos-Phi (2nd parameter set) nominal value

2 33. Switch on time target cos-Phi-2

2 34. Switch off time target cos-Phi-2

2 35. Connecting time

2 36. Disconnecting time

2 37. Discharge time

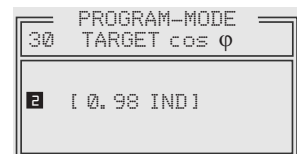
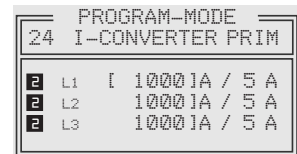

The programming of the 2nd parameter set is performed equivalent to the programming of the standard parameters (3-11; 17-19)

38 HARMONICS [7]% (0,5...25,5)%

Threshold value THD-V (in%). In case this value is exceeded a message will be displayed. THD-V ist the ratio of the geometric sum of unequal harmonics to the 1st harmonic. In any case, a warning will be displayed. Warning via message relay will only be executed if selected in 22.

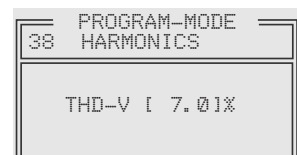

=== PROGRAM-MODE ===

- 39 CLOCK** [HH:MM], **DATE** [DD.MM.YY]
 Set system-time and date
 (Due to an internal battery the time will be kept even in case of power loss)
 Selection with ↑/↓. Save/continue with ENTER

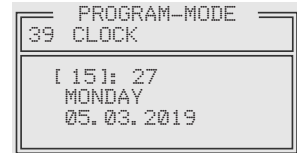

- 40 CONTRAST** [6] (0...10)
 Adjustment of display contrast for best readability
 Selection with ↑/↓. Save/continue with ENTER

- 41 BASIC SETTINGS** [NO] (YES/NO)
 When selecting YES and confirmed with ENTER, all parameters are set back to the basic settings of the panel builder (optimum values for the system if the controller has been delivered together with the PFC-system). If the controller has been delivered ex works, this point corresponds to the default settings.

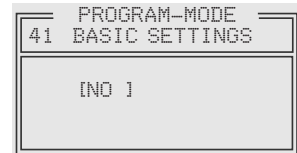

ATTENTION: All user settings get lost !

Section 6.1: PROGRAMMING LOCK

As a protection against unauthorized changes of the system parameters, the device is equipped with a programming lock. This can be activated in the EXPERT MODE. When the lock is active, all parameters can be checked but not changed.

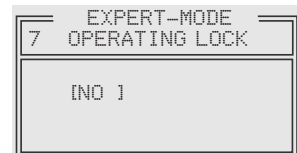

Alternatives:
 Lock active / Not active / Automatic activation after 24 h

Section 7: HELP-Functions / actual output assignment

The *Prophi 15T-III* features a context related help function. For each menu item one or more help pages are available which can be accessed directly with the HELP-button. Scrolling is done with "UP/DOWN" buttons, back retrace with ESCape.

In automatic operation (==AUTO-MODE==) 9 help pages are available. The first pages explain the general meaning of used symbols.

On the help pages 7..9 the actual assignment of the internal transistor outputs to the phases and to the capacitors are shown directly. This table depends on the CONTROL-MODE that is set and will change automatically.



The assignment shown here is not trivial, especially in CONTROL-MODE 2 (MIXED MODE) and must be obeyed without exception!

s. example next page

=== Actual assignment of outputs ===

Example: CONTROL-MODE 2 (MIXED-MODE)
 set in END STOP to:
 4 stages with 3 single- phase capacitors each and
 3 stages with 1 three-phase capacitor each

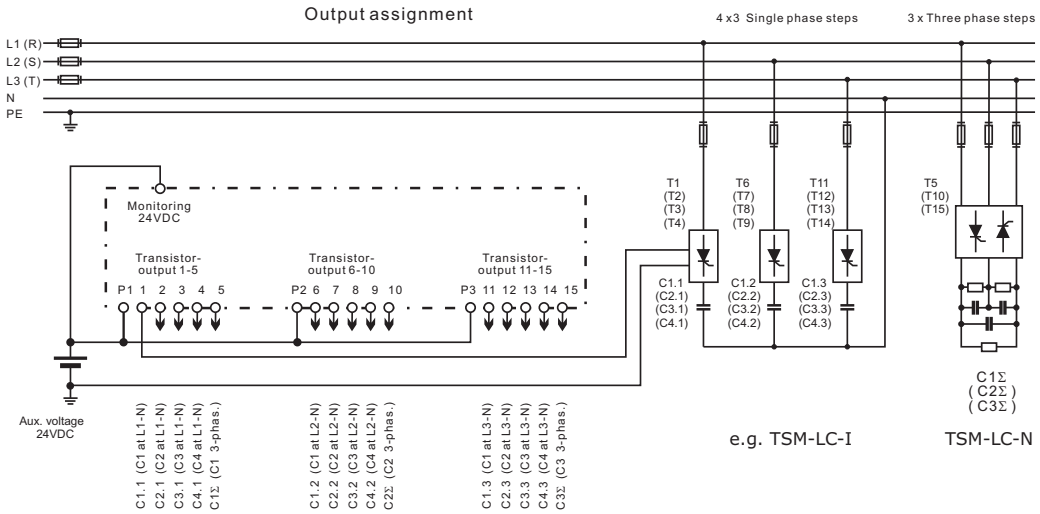

In case of the setting the controller will automatically assign the capacitors according to the wiring diagram.

This output assignment can always be called up in help-mode AUTO-MODE/ HELP/ page 7...9 and is displayed in the example as follows:

HELP-MODE p. 7/9
 OUTPUT ASSIGNMENT
 Thy T01 -> L1 -> C1.1
 Thy T02 -> L1 -> C2.1
 Thy T03 -> L1 -> C3.1
 Thy T04 -> L1 -> C4.1
 Thy T05 -> Σ -> C1Σ

HELP-MODE p. 8/9
 OUTPUT ASSIGNMENT
 Thy T06 -> L2 -> C1.2
 Thy T07 -> L2 -> C2.2
 Thy T08 -> L2 -> C3.2
 Thy T09 -> L2 -> C4.2
 Thy T10 -> Σ -> C2Σ

HELP-MODE p. 9/9
 OUTPUT ASSIGNMENT
 Thy T11 -> L3 -> C1.3
 Thy T12 -> L3 -> C2.3
 Thy T13 -> L3 -> C3.3
 Thy T14 -> L3 -> C4.3
 Thy T15 -> Σ -> C3Σ

Section 8: MANUAL OPERATION

Manual operation is designed for maintenance and service purpose. Menu "MANUAL-MODE" consists of the following sub-windows:

1 MANUAL CONTROL [STOP] L1 (L1...L3)

In manual operation, capacitor steps can be connected /disconnected **according to the control series** and switching time irrespective of the prevailing power-line-conditions.

Starting position is STOP (no stages connected).

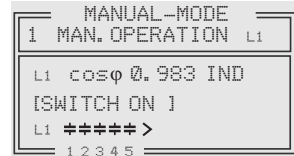

CONNECTION or DISCONNECTION is done by pressing the buttons **↑** resp. **↓**

This manual operation is executed consecutively for particular phases L1-L3 resp. Σ.

The operation status and the power power factor of the actual phase are permanently shown in the display.

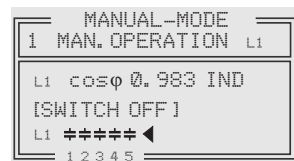

2 STEP STATE C1 - [AUTO] (FIXED/ AUTO/ OFF)

In special cases, all controller outputs (C1- C15) may be permanently defined (continued switching via ENTER) for the following states:

AUTO: Automatic (normal) operation

The relevant output is marked by a capacitor symbol.

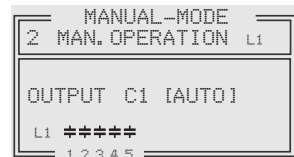

FIXED: The output is continuously connected, e.g. for fixed PFC. The output is marked by an underlined capacitor symbol.

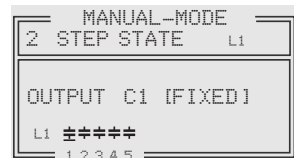

OFF: The output is continuously disconnected, e.g. for temporarily disconnecting of a defective capacitor. The capacitor symbol for this output is faded out. "MINUS" sign appears.

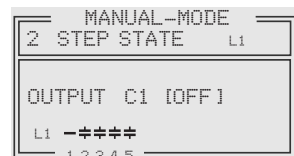

The active stage is blinking. The required status is set via **↑** / **↓**. By pressing ENTER, the user saves this step and moves to the next stage.

The programmed status for the outputs also remains visible on the display in automatic operation.

Section 9: SERVICE MENU / Fault memory

This service menu can be reached by the operating-mode key.

The recorded maximum values and the related time stamp can be retrieved here.

In addition, a fault memory is available where the last fault events of the system are stored in plain text (e.g. short-term over temperature or over voltage).

The related time stamp can be called up via UP/DOWN buttons.

Action	Display	Unit	3-phase
ENTER	1 min/max VOLTAGE	in V	L1 ... L3
ENTER	2 max. CURRENT	in A	L1 ... L3
ENTER	3 max. REACTIVE POWER	in kvar	L1 ... L3
ENTER	4 max. ACTIVE POWER	in kW	L1 ... L3
ENTER	5 max. APPARENT POWER	in kVA	L1 ... L3
ENTER	6 max. TEMPERATURE	in °C /°F	
ENTER	7 max. THD - V / THD-I	in % / bargraph	L1 ... L3
ENTER	8 MAX. VALUE RESET		
ENTER	9 ERROR MEMORY	in plaintext with time-stamp	
ENTER	13 ERROR MEMORY RESET		
ENTER	Back to 1		

Example ERROR display:
overcompensated in phase L3
with date / time stamp

SERVICE 1/20
9 ERROR MEMORY
capacitive load too high overcompensated L3 01.03.2019 - 15:00

Section 10: EXPERT-MODE 1 and 2

The expert modes are meant for the adjustment of values which normally should not be changed. As a protection these levels have access codes:

PASSWORD: ExpertMode 1: "6343"
 ExpertMode 2: "2244"

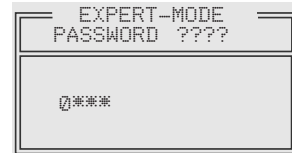

10.1 EXPERT-MODE 1 (Code: 6343)

- 1 BASIC SETTINGS NEW** [NO] (NO/YES)
 Storage of the present programming as a new basic setting (usually performed by the PFC-system manufacturer).
Caution: All original values will be overwritten!
- 2 SWITCHING POWER max** [100] kvar (multiple of smallest step)
 This factor specifies the maximum power which may be switched in one switching step. It can be used to control the intelligent control system, which switches several stages as a function of the power-factor requirement.
- 3 SWITCHING TRIGGER** [66]% IND (30...100%)
 Threshold for switching on of the next stage. (IND. direction)
- 4 SWITCHING TRIGGER** [66]% CAP (30...100%)
 Threshold for switching on of the next stage. (CAP. direction)
- 5 OPERATING LOCK** [NO] (NO / YES / 24H)
 24 H means, that the lock will be automatically after 24 hours.
- 6 CONTROL** [MEAN VALUE] (Mean /Maximum value)
 Only at single-phase measuring!
 Selection whether the control during single-phase measuring should be done according to the mean or the maximum value of the missing reactive power (of the 3 phases)
- 7 POWER 1st stage** [0...255] (0...2550)
 Here the range for the input of the 1st stage power can be set to [0...2550]
- 8 DISPLAY** [cos φ] (cos / tan φ)
 Switch over between COS Phi or TAN Phi in the display

=== EXPERT-MODE ===

- 9 HARMONICS** [NO] (NO/3. - 7. ... 3. - 31.)
 Setting of up to which maximum harmonic the calculation shall be done.
 Note: the more harmonics are calculated, the slower the display of the harmonics is updated!
- 10 C-FAULT(+)** [40]% (10...100%)
 Here the upwards deviation from the capacitor's nominal value can be determined.
 In case this value is reached, an error message is displayed.
 (available in operation mode 6 only)
- 11 C-FAULT (-)** [40]% (10...100 %)
 Here the downwards deviation from the capacitor's nominal value can be determined. In case this value is reached, an error message is displayed.
 (available in operation mode 6 only)
- 12 TEST ATTEMPTS** [6] (2...9)
 A C-error message is displayed only after these given numbers of consecutive measurements have indicated an error of the capacitor output.
 (available in operation mode 6 only)
- 13 SYMMETRY**
 Dynamic part of the compensation in the hybrid mode which is not transferred into static steps (application: fast switch off)
 Only available in the Hybrid mode: operation mode 7...14
- 14 PROTOCOL Com 1** [MODBUS-RTU]
- [None] - Interface switched off
 - [MODBUS KTR] - MODBUS- with interface monitoring
 - [MODBUS RTU] - MODBUS-protocol (default)

Depending on the selection of the protocol, the following configuration menu is offered:

- 15 BAUDRATE (symbol rate) Com1** [9600/NONE]
 possible transfer rates are:
 9600/ 19200/ 38400/ 57600/ 115200/ 128000/ 250000/ 256000 Baud
 each with parity NONE, ODD or EVEN
- 16 BUS-ADDRESS Com1** [1] (1... 255) address

10.2 EXPERT-MODE 2 (Code: 2244)

The 2nd expert mode defines all operation-, warning- and fault messages which can be displayed by the *Prophi 15T-III*. They can be activated/de-activated separately. When de-activated, the display of the message as well as the possible activation of the alarm-relay or consequent effects on the control behavior are suppressed.

1 NOTIFICATIONS / ALARM [YES] =activ (YES / NO)

Activation/De-activation of the particular operation,- warning- and default messages:

Measuring voltage, over voltage, over-/under compensated, harmonics, over-temperature, over-current, under-voltage, measuring current, error COM1, error COM2, Modbus switch off, Modbus-stop, Modbus switch on, system current <, Bus-error external, C-defect, System current >0, overload system, external error, C-defect off, Undervoltage aux. voltage 24DC

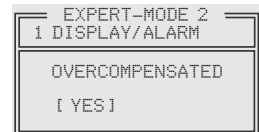

2 ALARM RELAY

Delay time [10] min. (1...255 min.)

3 UNDER VOLTAGE [50] % (20...95%)

If the measuring voltage falls below this value, all steps are simultaneously switched off.

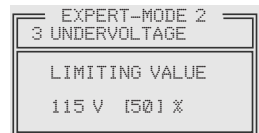

4 OVER VOLTAGE [115] % (105...140%)

If the measuring voltage exceeds this value, the stages are switched off step by step.

If the measuring voltage is again in the defined range, stepwise re-connection of steps is done.

5 THD-MEAN VALUE

Measuring cycles [3] (1...3)

6 UNDERVOLTAGE 24VDC (OFF/ <1 ... 24V)

Monitoring of auxiliary voltage 24 V

In case of undercut of the pre set limiting value the steps are switched off and an error message is displayed.

Section 11: CONTROL PRINCIPLE

The control behavior can be selected in the programming mode.

Generally, the *Prophi 15T-III* offers different possibilities of controlling:

● **SEQUENTIAL CONNECTION**

In sequential connection, the required capacitor stages are successively connected or disconnected step by step (last in first out). The ranking of each step always corresponds to the power of the smallest stage.

Advantage: exact definition of the next capacitor to be connected in each case.

Disadvantage: long reaction time, high switching frequency of small stages, uneven strain on the capacitors.

In order to shorten the setting times nevertheless, the controller simultaneously switches several steps in case a higher power factor correction is required.

This applies to all control modes.

The maximum size of the simultaneously switched branches can be changed in EXPERT-MODE 1. If the value of the smallest stage is pre-selected, the conventional sequential connection is obtained.

● **LOOP CONNECTION**

In this variant, the controller operates in loop connection (first in - first out) which minimizes the wear off of the system. E.g. in case of stages of same value always the stage that has been disconnected for the longest time is connected next.

Advantage: even utilization of stages, increase of life time of system.

Disadvantage: only effective for control series with groups of same stage power, long reaction times.

● **INTELLIGENT (Factory setting)**

The intelligent control principle combines the advantages of the system-saving loop connection (first in first out) with a significantly higher setting time even in case of high load skips, and reaches this target with the fewest possible switching operations of capacitor steps. The optimized time behavior is reached by simultaneous switching of several or larger capacitor groups depending on the missing reactive power in the grid. Additionally, the number of real switchings of the capacitors as well as switch-in times of the branches are considered.

Advantage: Reaching of target cos-phi in fast, optimized setting times in combination with a low switching frequency of the capacitor.

● **COMBINED DE-TUNING** (Special case for combined de-tuned systems)

Pair wise de-tuning requires an appropriate control series (e.g. 1:1:1:1..., 1:1:2:2:..., 1:1:2:2:4:4...). The condition for the switching behavior is defined in a way that the number of connected odd steps always is higher or equal to the number of connected even steps. The controller fulfills the requirements in the control regime whilst largely conforming to the switching behavior.

Section 12: INTERFACES

As a standard, the *Prophi 15T-III* is equipped with two isolated RS485 interfaces according to the following assignment:

View from bottom :

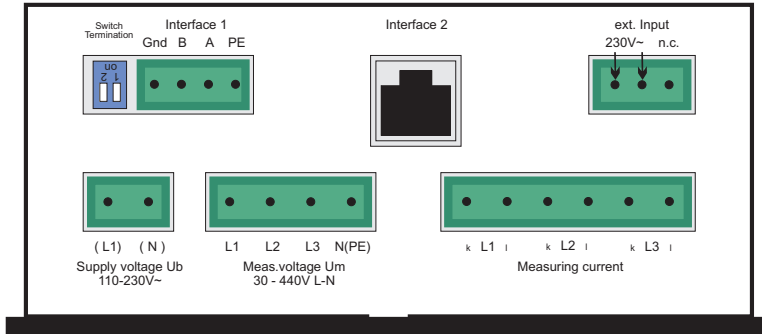

The following functions can be realized via the interfaces:

- Remote read out of grid parameters, storage, display, grid analysis
- Usage as system interface for connection of accessories or for coupling of two controllers
- Usage for customer specific applications (facility master control system, SPC etc.)
- Usage in a network (MODBUS-Protocol)

Interface 1 mainly designed for customer specific applications, whilst Interface 2 intended for coupling with accessories.

Coupling with a PC for the usage of Windows-Software can be done from both interfaces with accessory "USB-adapter".

RS485- Bus structure

All devices are connected to one line in parallel. This requires a direct connection of the bus lines to the plug connection of the device (no junction box).

Cable

For connection a twisted and shielded cable has to be used. The shielding has to be connected with casing or cabinet parts at both ends.

Max. cable length in the bus is 1,200 m (depending on cable and baud rate).

At the first and at the last device of the bus the cable has to be terminated with resistors. Activation (termination) on the controller side is done with the switch "Termination" next to the clamp "Interface1" (both white switches on "ON").

12.1 Application: Controller coupling

Attention: Controller coupling only possible in CONTROL-MODE 15 or 16 !

Application example:

Two separate systems operate at two transformer feed ins; it exists one coupling with coupling switch between both systems.

- Coupler opened; both systems operate self-governed;
- Coupler closed: with the controller coupling both systems are operated symmetrically in *parallel operation* (same number of steps in each system)

Coupling of 2 power factor controllers *Prophi 15T-III* is done via their system interface with a standard LAN-cable.

The 110...230V~ signal "coupling switch closed" has to be directed to the external input of a controller (master). On this controller the programming has to be done as follow:

PROGRAMMING: 2 CONTROL-MODE: 15 or 16 (coupling mode)

On the 2nd controller (slave) the setting is the corresponding control-mode (4 or 5)

No more settings are required !

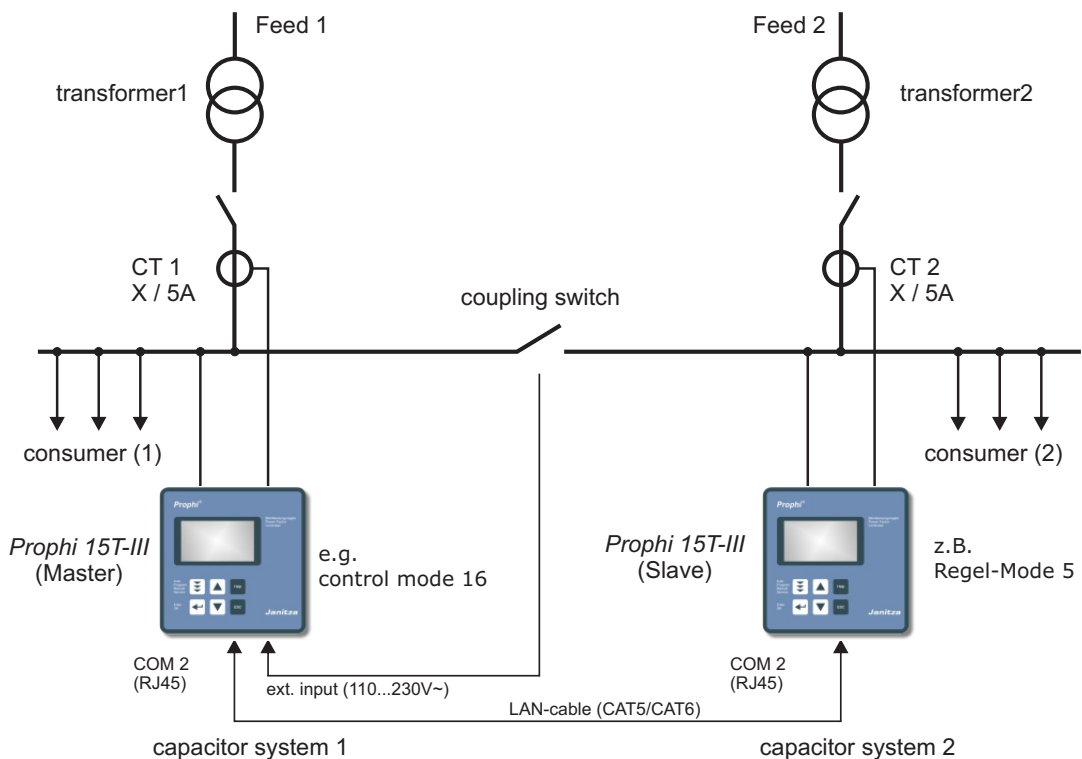

12.2. Application HYBRID-MODE : *Prophi 15T-III* and *Prophi 12RS*

A mixed dynamical compensation system implements economically the advantages of a dynamic fast network. (Fast changing loads are compensated dynamically and basic loads / slowly changing loads are compensated conventionally)

For designing a mixed-dynamical compensation system a special controller was developed. The *Prophi-12TR* supports up to 12 transistor-outputs (for triggering thyristor modules) and additional 12 relay-outputs for standard capacitor contactors.

In systems where more than 12 outputs are required respectively where the dynamic part is to be compensated for single phases, following application can be used. Here the dynamic part is compensated by the *Prophi 15T-III* (single or three phase) and the base load is compensated conventionally by the *Prophi-12RS*.

Programmierung und Anschluß

Prophi 15T-III
(for dynamical steps)

Menu: PROGRAMMING

2 CONTROL-MODE: 7...14

up to 2 ***Prophi-12RS***
(für conventional steps)

Menu: INTERFACE

Protocol: [Slave Hybrid]
Baudrate: [38400/NONE]
Adress: [1] Adress: [2]

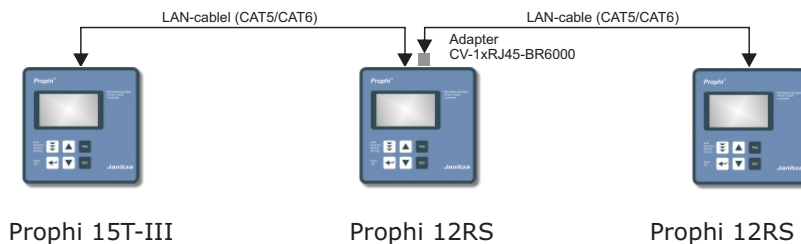

Section 13: ALARM RELAY / ERROR MESSAGES

The contact of the **alarm relay** (compare page 5) is closed during normal operation and opens in case of failure. At the same time, the respective error is indicated in plain text in the display:

UNDER COMPENSATED missing reactive power	- display and relay
OVER COMPENSATED	- display and relay
OVER CURRENT	- display and relay
MEASURING VOLTAGE ???	- display and relay
OVER TEMPERATURE	- display and relay
OVER VOLTAGE	- display and relay
UNDER VOLTAGE	- display and relay
HARMONICS	- display and relay

Additionally, several messages for different operation states are generated. An individual adjustment resp. masking of single messages is possible in EXPERT-MODE 2.

During masking, the display of message, the eventual output via alarm relay and possible influences on the control process are suppressed.

Section 14: DISPLAY-EDITOR



To be reached via button operation mode in the main menu.

In Display editor the values that will be permanently shown in the display mode 1 (s. large letter indication) can be selected.

Out of all measuring values that are available for each line (three lines in total) the desired value can be selected.

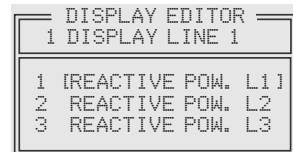

Section 15: OSCI-MODE



To be reached via button operation menu in the main menu.

In Osci-mode the actual form of a period of voltage and current is graphically displayed. This provides information about phase shift and curve form. Display possible consecutively for L1...L3

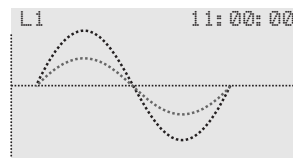

Section 16: MAINTENANCE AND WARRANTY

No maintenance is required when operation conditions are obeyed. Nevertheless a functional check of the controller together with the rotational check of the compensation system is recommended.

The typical life expectancy of the internal Li-battery is min. 8...10 years. It is firmly connected to the circuit board and should only be exchanged by the manufacturer.

In the event of any interventions in the controller during the warranty period, all warranty claims lapse.

Annex 1: Table of control series

No.	Control serie	Loop connection
1	1 : 1 : 1 : 1 : 1	possible
2	1 : 2 : 2 : 2 : 2	possible
3	1 : 2 : 3 : 3 : 3	possible
4	1 : 2 : 3 : 4 : 4	possible
5	1 : 2 : 4 : 4 : 4	possible
6	1 : 2 : 3 : 6 : 6	possible
7	1 : 2 : 4 : 8 : 8	possible
8	1 : 1 : 2 : 2 : 2	possible
9	1 : 1 : 2 : 3 : 3	possible
10	1 : 1 : 2 : 3 : 6	possible
11	1 : 1 : 2 : 4 : 4	possible
12	1 : 1 : 2 : 4 : 8	possible
13	1 : 1 : 1 : 2 : 2	possible
14	1 : 1 : 1 : 2 : 3	possible
15	1 : 1 : 1 : 2 : 4	possible
16	1 : 1 : 1 : 2 : 5	possible
17	1 : 1 : 1 : 1 : 2	possible
18	1 : 1 : 1 : 1 : 3	possible
19	1 : 1 : 1 : 1 : 4	possible
20	1 : 1 : 1 : 1 : 5	possible
"ED"	Control-series editor	possible

Control series editor: Programming of step values up to 30

The control series editor enables easy creation of own control series in case the required control series is not available.

In "PROGRAM-MODE" the last control series - control series ED - has to be selected and confirmed by ENTER. This adds an additional menu point to the main menu -> control series editor. It can be accessed via button „operation mode“.

In the control series editor all stages can be set consecutively to the desired value with the selection buttons \uparrow/\downarrow . Pressing ENTER leads to the next stage.

In the control series editor the particular stages can be programmed up to a value of 30 (!). The values >9 are displayed as follows:

10=A, 11= B, 12=C, 13=D, 14=E, 15=F, 16=G 30=U

Attention: All control series can be edited (even downwards). Whether an edited control series "makes sense" is the decision of the customer.

Maximum number of stages can be limited by a programmed ENDSTOP.

By pressing button "Operation mode" the editor is left.

Annex 2: Troubleshooting

Fault	Reasons / Solution
For target $\cos \text{PHI}=1$ and inductive load steps are switched out / for the already compensated grid steps are switched in Supply and consumption exchanged.	Check terminals of measuring voltage and measuring current (l and k)! Check phase position! Check phase allocation (voltage/current in same phase)
Wrong $\cos \text{Phi}$ is displayed	See above
Display "Measuring current<??" (UNDERCURRENT)	Current in measuring range ? Line interruption ? Wrong current-converter factor ? Current transformer short-circuited ?
Display: "OVERCURRENT" Alarm relay: after 10 min.	Check ratio of current transformer (1/5A) Go through measuring current range
Display: "UNDERCOMPENSATED" Alarm relay: after 10 min.	Check connections and phase position ! All stages connected, target PF not reached: - system sufficient dimensioned ?
Display: "OVERCOMPENSATED" Alarm relay: after 10 min.	Check connections and phase-position ! Capacitive grid although all stages are disconnected
Display: "MEASURING VOLTAGE ??" Alarm relay: after 10 min.	Measuring voltage missing !
Display: "UNDERVOLTAGE" Alarm relay: after 10 min.	Measuring voltage (in programming) must be in line with real terminal voltage Check programming over-/under voltage range in EXPERT-MODE 2!
Display: "OVER-TEMPERATURE" Alarm relay: after 10 min.	System temperature too high ! Outputs are switched off in stages irrespective of power line conditions.
Display: "HARMONICS" Alarm relay: after 10 min.	Stages switch off consecutively according to the programmed time and control series. Check grid conditions! If permissible: increase threshold TDH-V (7 %)
Undervoltage 24V	Check auxiliary voltage 24V!

Fault	Reasons / Solution
In inductive grid stages are switched off resp. in capacitive grid conditions stages are switched on	In case a value other than 1 for target- cos-phi is pre-set, the display "<" may be illuminated despite an inductive grid load. Arrows indicate the control direction, not the grid conditions!
The controller does not connect all stages or cos-phi does not change at the last stages	Check END STOP! Check CONTROL-MODE!
	Check whether in the menu "Manual operation/fixed steps" particular steps have been programmed as fixed steps or as OUT
Connected capacitor contactors are not in line with the expected capacitor stages.	Check allocation of outputs to capacitors: In program mode HELP-button call page 7-9 > table of allocations is displayed. Check control-mode and END STOP!
After turn-on, display shows "SYSTEM TEST"	System test is for checking of the device when starting. If the page appears, at least one test is not OK. The error may be read, but not solved here. Please contact your local service. Depending on the error (e.g. internal battery empty) the device can be used anyhow. Quit screen with "ESC".
The system permanently switches capacitors on and off although the number of consumers does not change (system oscillating).	Check programming and the capacitance of the smallest stage. Check programming and the values of the current converters. Check programming of the control series and the capacitance of the capacitors.
Operation voltage missing	Note: no display, alarm relay open

Annex 3: Technical Data

Type series	Prophi 15T-III
Operating voltage	110...230 V~, +/-15%, 50 / 60Hz
Measuring voltage (3-phase)	3 · 30...440 V~ (L-N) / 50...760V~ (L-L)
Measuring current (3-phase)	3 · X : 5 / 1A selectable
Power consumption	< 3 VA
Sensitivity	50 mA / 10mA
Switching power	
Outputs for capacitor branches (switch.voltage 24VDC, 3x120mA)	15 transistor outputs: freely programmable for switching of single- and three-phase capacitors
Alarm relay	1
Message relay	1, programmable
Relay for panel fan	1
Number of active outputs	programmable
Operation and display	illuminated full graphic display 128x64 dot
Menu Languages	Ger / E / ES / RU / TR
Number of control series	20
User-defined control series	1 via editor
Controlling	true controlling of each phase (L-N) und (L-L)
Modes of operation (1- and 3-phase)	1- phase: up to 3 · 5 single phase capacitors 3- phase: up to 15 three-phase capacitors mixed Mode: for balancing and compensation
Control principle	series switching, circular switching, self-optimized intelligent switching, 4-quadrant operation
Meas.of true current of capacitor-system	possible
Target- $\cos \varphi$	0.3 ind. ... 0.3 cap adjustable
2 nd target $\cos \varphi$ (time- or result controlled)	0.3 ind. ... 0.3 cap adjustable
Switch on time	selectable from 50 - 1000 ms
Switch off time	selectable from 50 - 1000 ms
Discharge time	selectable from 50 - 1000 ms
Internal clock / several timers	yes
Manual operation	yes
Fixed steps / skip steps	programmable
Zero voltage release	standard
Aux. voltage for transistor outputs	24VDC

Display / Display functions	
Display of grid parameters As real value/in %/as bar graph	3-phase cos-Phi, voltage, current, reactive-, active-, apparent power, missing kvar, temperature, THD-U / THD-I
Large display of 3 grid parameters	selection via display-editor
Harmonics	3. - 31. harmonics of U and I display also in % or as bar graph
Osci-mode	graphical display of 1 period U/I in oscilloscope mode
Precision	current / voltage: 1% active, reactive, apparent power: 2%
Integrated auxiliary function	context depending, plain text
Storage function	
Storage of maximum values with time stamp	voltage, current, reactive-, active-, apparent power, temperature, THD-V, THD-I
Temperature measuring range	-30 ... 100°C
Temperature monitoring	automatic switching-off of steps
Error storage	error register in plain text with time stamp
Interface	
Software for visualization, display and recording of grid parameters	2 independent isolated interfaces RS485 (MODBUS RTU, system interface) enclosed in delivery
External Input	110...230V~ isolated
Complete 2nd parameter set	via external input or event driven
Casing	
Weight	panel-mounted instrument DIN 43 700, 144 x 144 x 60 mm 1 kg
Operating ambient temperature	-20 ... +60°C
Protection class accord. IEC 60529	front: IP 54, rear: IP 20
Safety standards	IEC 61010-1: 2010
Interference resistance	IEC 62053-23: 2017; IEC 61326-1: 2013
EMV-resistance	EN 50082-1: 1997 IEC 61000-4-2: 8kV IEC 61000-4-4: 4kV

Annex 4: Factory settings

Note: The following values for the default settings apply only if the controller is supplied directly from the manufacturer. Otherwise, these values may have been replaced by settings made by the manufacturer of the compensation system (optimal values for the relevant network)

No.	Parameter	Default setting	Programmed values of this system (to be entered by manufacturer or operator)
1	LANGUAGE	ENGLISH	
2	CONTROL-MODE	[1] 3x5 single-phase capacitors L-N	
3	I CONVERTER PRIM.	1000 A	
4	I CONVERTER SEC.	5 A	
5	END STOP	3 x 5	
6	CONTROL SERIE	1	
7	CONTROL PRINCIPLE	INTELLIGENT	
8	POWER 1st STAGE	25.00 kvar	
9	TARGET COS-PHI	0.98 IND	
10	TARGET 2nd COS-PHI	- NO -	
14	MEASURING VOLTAGE	L-L 400 V (L-N 230V)	
15	V-CONVERTER	- NO -	
16	FREQUENCY	50 Hz	
17	CONNECTING TIME	1000 ms	
18	DISCONNECT. TIME	1000 ms	
19	DISCHARGE TIME	1000 ms	
20	ALARM TEMPERATURE	55°C	
21	FAN TEMPERATURE	30°C	
22	MESSAGE RELAY	OFF	
23	EXT. INPUT	- NO -	
38	HARMONICS THD-V	7 %	
39	CLOCK / DATE		
40	CONTRAST	6	
41	BASIC SETTINGS	- NO -	

No.	Parameter 2nd parameter set / EXPERT-MODE	Default setting	programmed values of this system (to be entered by manufacturer or operator)
23- 36	Values 2nd parameter set Expert-Mode:		Default values are the same as in the 1st parameter set.
	Code Expert-Mode 1	6343	Cannot be changed
	Code Expert-Mode 2	2244	Cannot be changed
1	BASIC SETTINGS	- NO -	
2	SWITCH.POWER	4 x smallest stage	
3/ 4	SWITCH.TRIGGER	66 %	
5	OPERATING LOCK	- NO -	
6	CONTROL*	MEAN VALUE	
7	OUTPUT 1st STEP	[0...255]kvar	
8	DISPLAY	COS Phi	
9	HARMONICS	[3. - 7.]	
10	C- FAULT (+) *	40 %	
11	C- FAULT (-) *	40 %	
12	TEST ATTEMPTS *	6	
13	SYMMETRY	0 %	
14	PROTOCOL*	MODBUS-RTU	
15	BAUDRATE/ PARITY*	9600/NONE	
16	ADRESS *	1	

```

AUTO-MODE 1/2
L1 cosφ 0.869 IND
L2 cosφ 0.869 IND
L3 cosφ 0.869 IND
L1 ****>
L2 ****>
L3 ****>
1 2 3 4
    
```

only available if control serie "ED" is selected

===== PROGRAM-MODE =====

CONTROL SERIES EDITOR

1 LINE VOLTAGE
L1-N 230 V
L2-N 230 V
L3-N 230 V
PE-N 0 V

2 APPAR CURRENT
L1 123 A
L2 239 A
L3 167 A

3 REACTIVE POWER
L1 88 kvar
L2 88 kvar
L3 88 kvar
Σ 264 kvar

4 ACTIVE POWER
L1 88 kW
L2 88 kW
L3 88 kW
Σ 264 kW

5 APPARENT POWER
L1 88 kVA
L2 88 kVA
L3 88 kVA
Σ 264 kVA

6 DIFF. TO PF
L1 12 kvar
L2 24 kvar
L3 16 kvar
N 52 kvar

7 TEMPERATURE
25 °C

8 HARMONICS [3.]
L1 V 0.5% I 1.0%
L2 V 0.8% I 1.0%
L3 V 0.5% I 1.0%

9 HARMONICS THD
L1 V 0.3% I 0.2%
L2 V 0.3% I 0.2%
L3 V 0.3% I 0.2%

10 COMP.-POWER
100 kvar / 7%

11 TIME / DATE
12:56:07
TUESDAY
05/26/2016

12 SOFTWAREVERSION
VERSION 1.2

BACK TO 1

1 LANGUAGE [2]
[ENGLISH]

2 CONTROL-MODE [1]
[3] PHASE MEASURING
max. [3x5 single ph]
capacitors PH-N

3 I-CONVERTER PRIM
L1 [1000] A / 5 A
L2 1000 A / 5 A
L3 1000 A / 5 A

4 I-CONVERTER SEC.
L1 1000 A / [5] A
L2 1000 A / [5] A
L3 1000 A / [5] A

5 END STOP L...-N
L1-N # # # # # [5]
L2-N # # # # # 5
L3-N # # # # # 5

6 CONT.SERIES L...-N
L1-N 1 1 1 1 1 [1]
L2-N 1 1 1 1 1 1
L3-N 1 1 1 1 1 1

7 CONTR.PRINC. [3]
[INTELLIGENT]

8 POWER 1st STAGE
L1 [25] .00 kvar
L2 25 .00 kvar
L3 25 .00 kvar

9 TARGET cos.φ
[0.98 IND]

10 TARGET 2nd cos.φ
[NO]

11 TARGET 2nd cos.φ
[0.98 IND]

12 SWITCH ON TIME φ2
ON [16] : 00 MO-FR
OFF 07 : 00 MO-FR

13 SWITCH OFF TIME φ2
ON 16 : 00 MO-FR
OFF [07] : 00 MO-FR

14 MEASUR. VOLTAGE
L - L [400] V
L - N 230 V

15 V-CONVERTER
[NO]

16 FREQUENCY
[50] Hz

17 - 19 ... TIME
C-ON [1000] ms
C-OFF 1000 ms
C-DIS 1000 ms

20 ALARMTEMPERATURE
[55 °C]

21 FAN TEMPERATURE
[30 °C]

22 MESSAGE RELAY [1]
[ENERGY SUPPLY]

23 EXT. INPUT [1]
[NO]

24 - 37 Values 2nd parameter set
(if selected at item 23)

38 HARMONICS
THD-V [7.0] %

39 CLOCK / DATE
[HH] : MM
WEEKDAY
TT : MM : JJJJ

40 CONTRAST
***** [6] *****

41 BASIC SETTINGS

BACK TO 1

VALENCY C01 [1]
① 1

selection until (max.) C15
with button ENTER

VALENCY C15 [1]
1 1 1 1 1 1 1 1 1 1 1 1 1 1 ①

BACK TO 1

E

Changing of values by buttons:



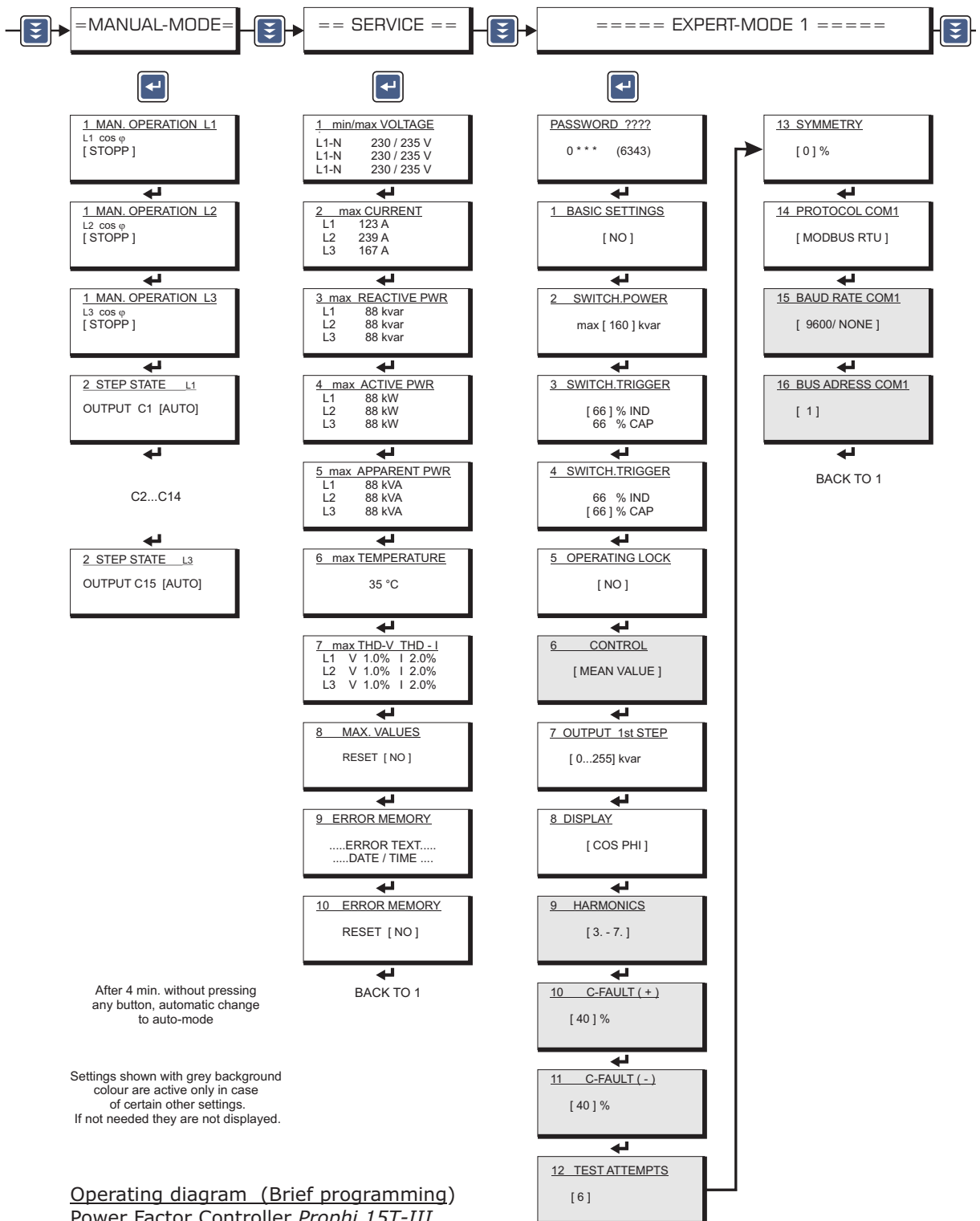

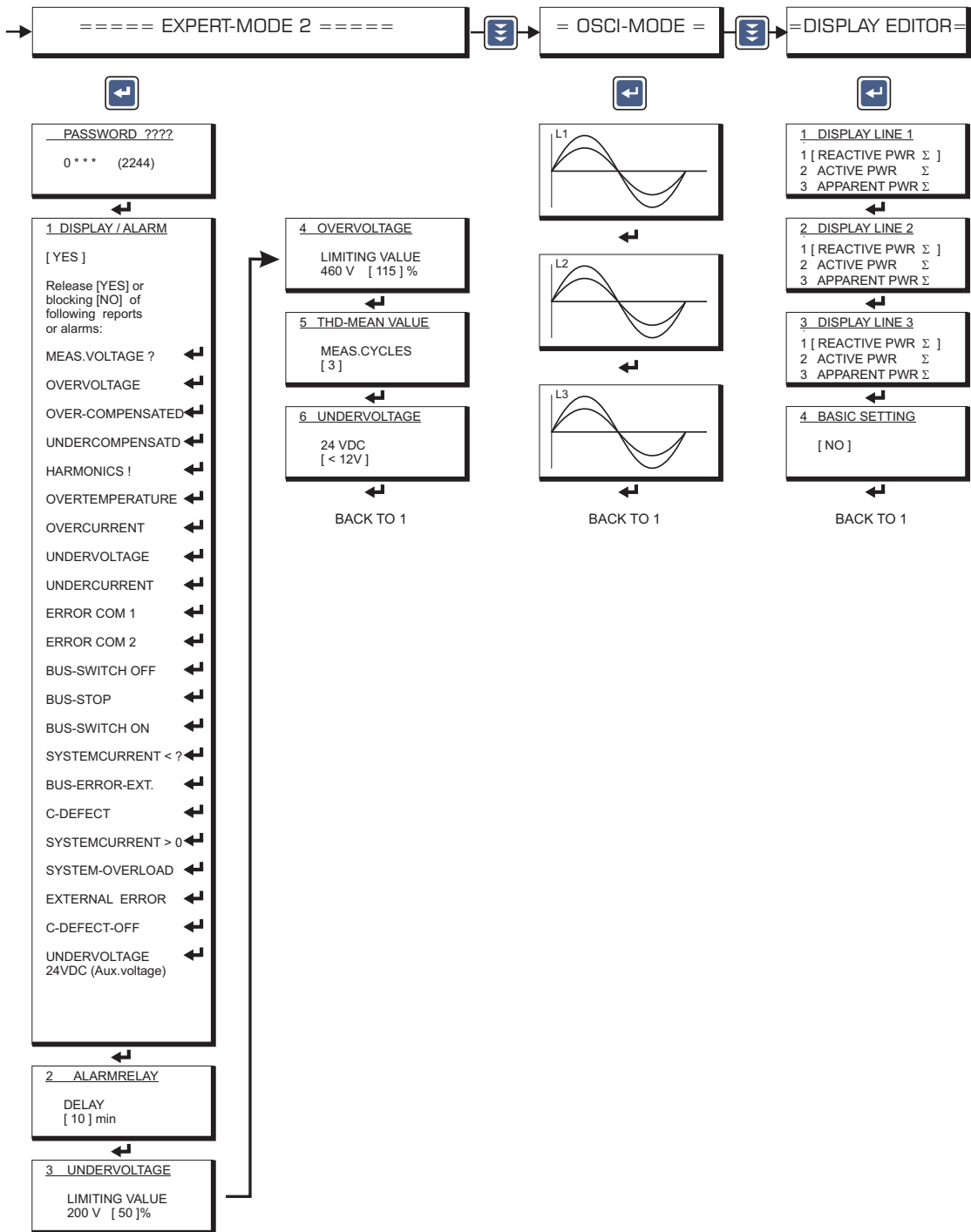

Accessories

RJ45-adaptor
connect several devices
to a RS485-Interface
via LAN-cable

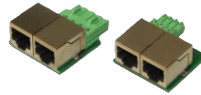

Thyristor switches
10 ... 200kvar / 400 ... 690V

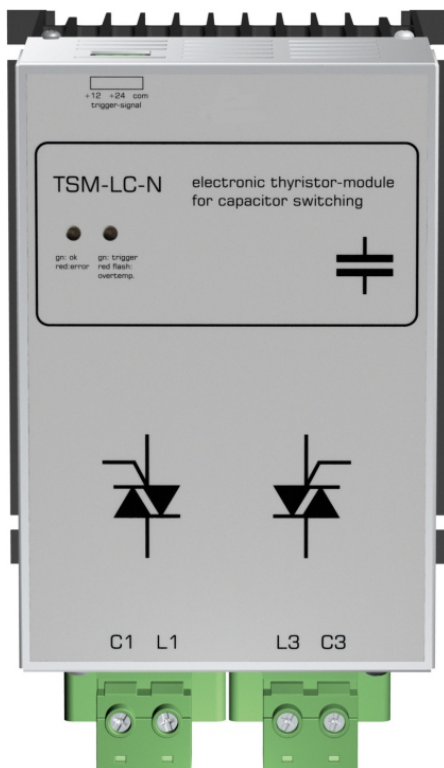

Janitza electronics GmbH
Vor dem Polstück 6
D-35633 Lahnau

Tel.: +49 6441 - 9642-0
E-Mail: info@janitza.de
info@janitza.de | www.janitza.de

Janitza[®]